

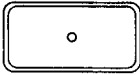

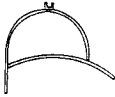





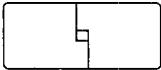
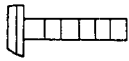

SEAFARER 72" x 42" RECTANGULAR TABLE

PARTS LIST

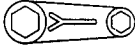
NO.	DESCRIPTION		Qty
A	Table Rim with Glass Top		1
B	Table Leg		4
C	Glass Bumper		6
D	Supporting Tube		2
E	Leg Connector Ring		1
F	Bolt (8 of 12 are pre-attached to the legs)		12
G	Lock Washer (8 of 12 are pre-attached to the legs)		12
H	Nuts		4
I	Hex Screw Driver		1
J	Wrench		1
K	PVC Screw Cover		12
L	PVC Nut Cover		4
M	Touch-Up Paint Bottle		1

FOR CUSTOMER SERVICE, PLEASE WRITE OR CALL:

FOREMOST INTERNATIONAL
906 MURRAY ROAD
EAST HANOVER, NJ 07936

TEL: 1-800-443-1410

FAX: 1-973-428-6166

EMAIL: customerservice@foremostgroups.com

Visit our web site at www.fitnjo.com

ASSEMBLY INSTRUCTIONS

1. Remove the table from the carton and place the Table Rim with Glass Top (A) upside down on a soft surface. Identify all parts packed in the carton against the parts list.
2. Remove the Bolts (F) and Lock Washers (G) from the Table Legs (B).
3. Insert all Glass Bumpers (C) into the Table Legs (B) and Supporting Tube (D) as shown in Figure 1. The glass bumpers (C) will protect the table glass from the table legs.
4. Slide all four Table Legs (B) and the two supporting tubes (D) into the plastic leg receivers as shown in Figure 2. Remember the glass bumper located on the leg is facing the bottom of the glass top.
5. Insert one Bolt (F) with a Lock Washer (G) into each hole from the inside of the Leg Connector Ring (E) and secure into the Table Legs (B). At this point, please do not secure them tightly.
6. Insert one Bolt (F) with a Lock Washer (G) into each hole from the inside of the Leg Connector Ring (E) and secure with a Nut (H) from outside of the Leg Connector Ring (E) into the Supporting Tubes (D) At this point, please do not secure them tightly.
7. Check alignment of all Legs (B) and the supporting tubes (D) and correct if necessary, to be sure 12 Bolts (F) and Nuts (H) are secured into the Legs. Tighten all Bolts (F) with Hex Screw Driver (I) and Nuts (H) with Wrench (J).
8. Cover all Bolts (F) with PVC Screw Covers (K) and all Nuts (H) with PVC Nut Covers (L) and then turn the table to an upright position with the help of another person. Your table is now ready to use, see Figure 3.

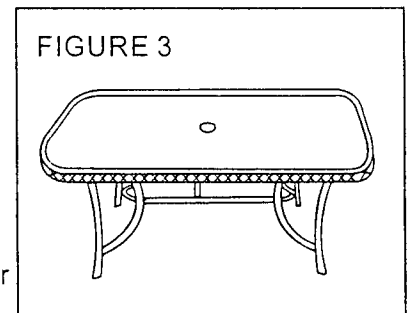
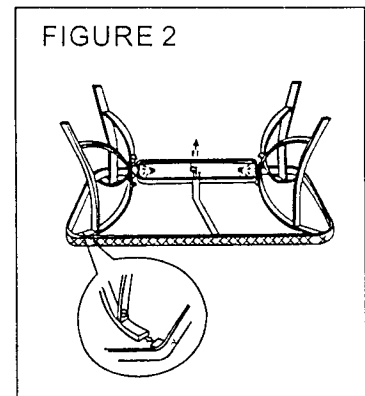
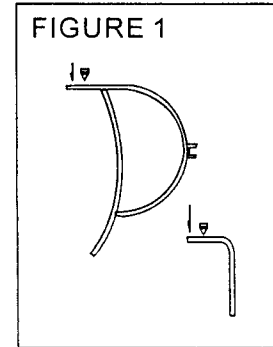

* Keep the Touch-Up Paint Bottle (H) for future use for both your table and chairs.

NOTE:

Repeated assembly can weaken the locking ability of the washers. Periodically check all bolted connections on your furniture to make sure they are tight and secure. Retain these instructions for future reference.

CAUTION:

- If you are using an umbrella with the table, make sure that the plastic ring is inserted into the hole in the center of the table and insert the umbrella through the opening. Use a cast iron or steel plate base or a plastic blow molded umbrella base that can hold a minimum of 50 lbs. Do not insert the umbrella into the table without using a base.
- Be sure close the umbrella when not in use and do not leave the umbrella in the open position during windy conditions.