

Seafarer 60" Square Wicker Table

ASSEMBLY INSTRUCTIONS

1. Remove the table from the carton and place the Tabletop upside down on a soft surface. Identify all parts packed in the carton against the parts list.
2. Remove the Bolts (F) (G) and Lock Washer (E) from the Metal Legs (B) and Tilted Braces (C).
3. Insert all Glass Bumpers (M) into each Metal Legs (B) as shown in Figure 1. The glass bumpers will protect the table glass from the metal legs.
4. Slide all four Legs (B) into the plastic leg receivers as shown in Figure 2, and also insert the tilted braces into the plastic receivers. Remember the glass bumper located on the leg is facing the bottom of the glass top. Insert one Bolt (F) with a Lock Washer (E) in each hole from the inside of the leg Connector Ring and secure into the table Legs. At this point, please do not secure them tightly. Check alignment of all Legs and correct if necessary, to be sure all 16 Bolts are secured into the Legs and tilted braces. Tighten all Bolts with Hex screwdriver (I).
5. Cover all Bolts with PVC Screw Covers (H) and turn the table to an upright position with the help of another person. Your table is now ready to use as shown in Figure 4.

* Keep the Touch Up Paint Bottle (N) for future use for both your table and chairs.

NOTE:

Repeated assembly can weaken the locking ability of the washers. Periodically check all bolted connections on your furniture to make sure they are tight and secure. Retain these instructions for future reference.

CAUTION:



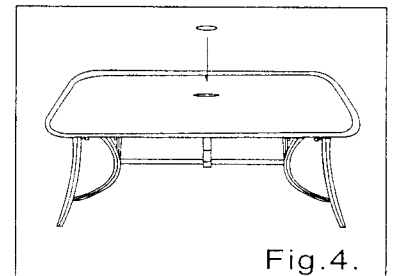
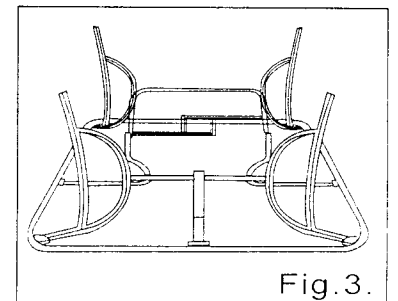
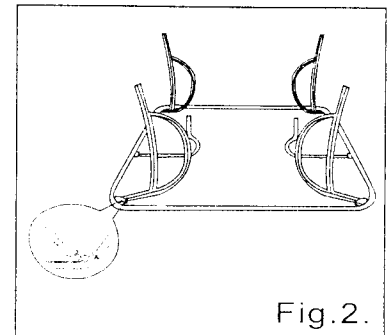
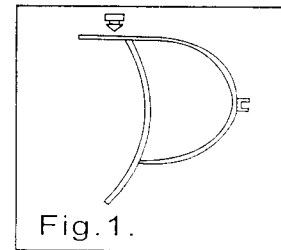





If you are using an umbrella with the table, make sure that the plastic ring is inserted into the hole in the center of the table and insert the umbrella through the opening. Use a cast iron or steel plate base or a plastic blow molded umbrella base that can hold a minimum of 50 lbs. Do not insert the umbrella into the table without using a base. Be sure close the umbrella when not in use and do not leave the umbrella in the open position during windy conditions.

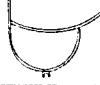
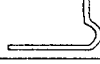
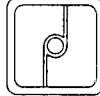

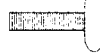
Seafarer 60" Square Wicker Table

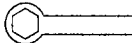
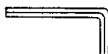
Item # FI-6066

Parts List

PARTS	DESCRIPTION	PICTURE	QTY
A	Table Top with Glass		1
B	Leg		4
C	Tilted Brace		4
D	Leg Connector Ring		1
E	Washer		16
F	M6*30 Bolt		8
G	M6*40 Bolt		8
H	Screw Covers		16
I	Hex Screw Driver		1
J	Nut Wrench		1
K	Nut		8
L	Plastic Nut M6		8
M	Glass Bumper		8
N	Touch-Up Paint Bottle		1

FOR CUSTOMER SERVICE, PLEASE WRITE OR CALL:

FOREMOST INTERNATIONAL
906 MURRAY ROAD
EAST HANOVER, NJ 07936

TEL: 1-800-443-1410

FAX: 1-973-428-6166

EMAIL: customerservice@foremostgroups.com

Visit our web site at www.fitnjo.com